

PANEL MOULDINGS

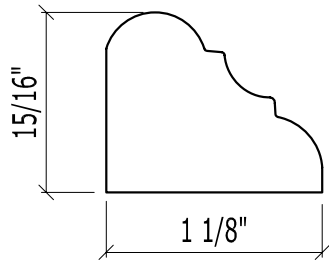

PM 001

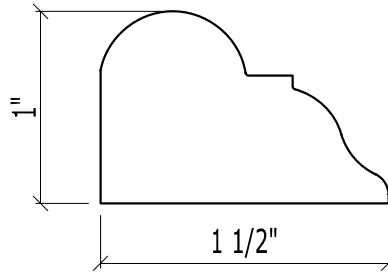

PM 002

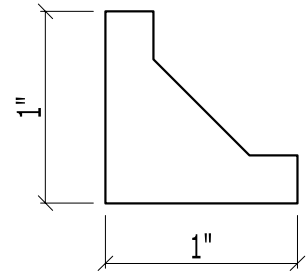

PM 003

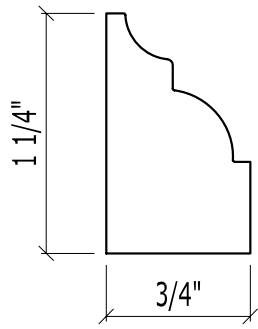

PM 004

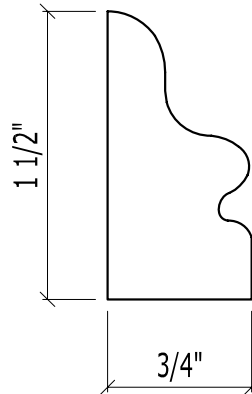

PM 005

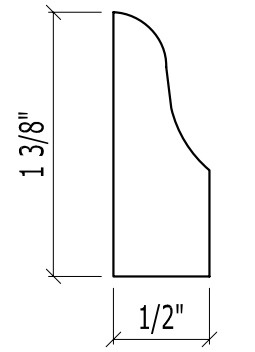

PM 006

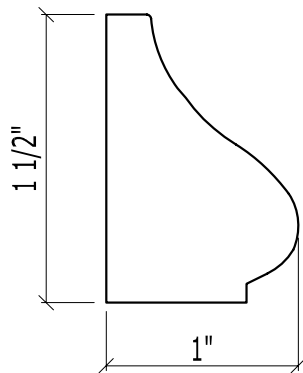

PM 007

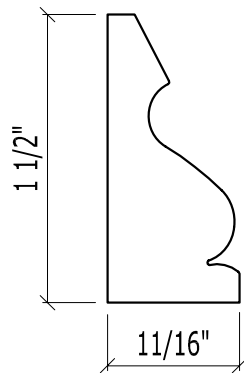

PM 008

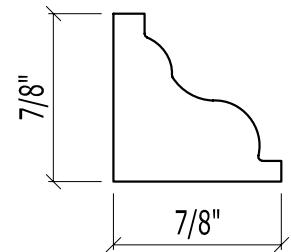

PM 009

PANEL MOULDINGS

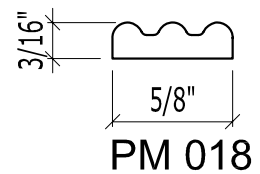
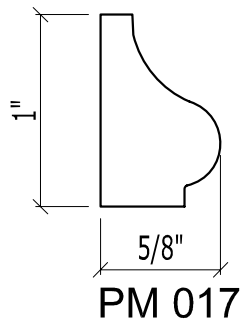
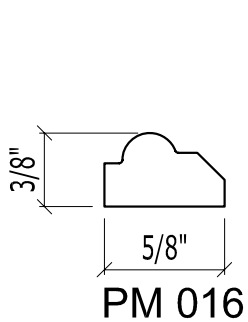
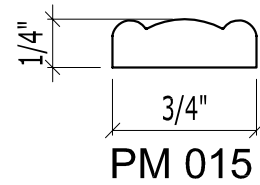
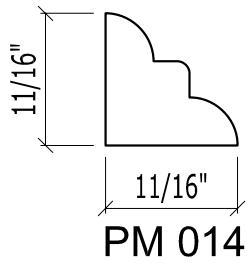
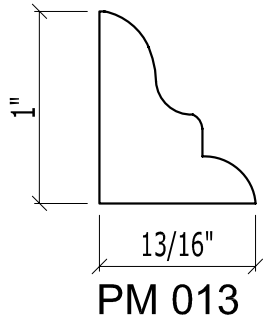
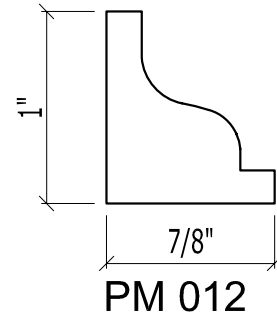
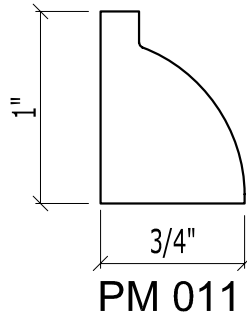
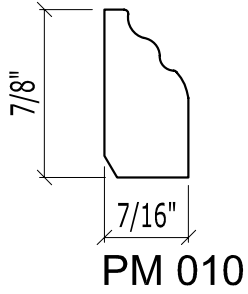

PANEL MOULDINGS

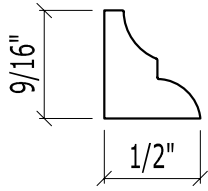

PM 019

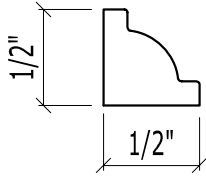

PM 020

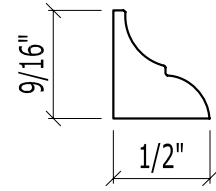

PM 021

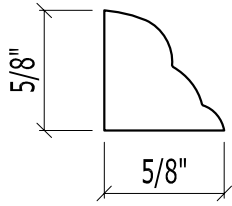

PM 022

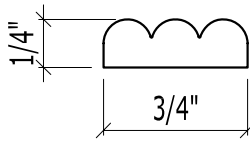

PM 023

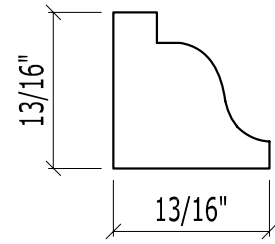

PM 024

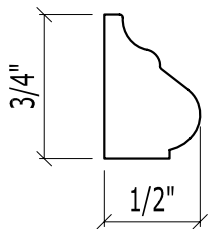

PM 025

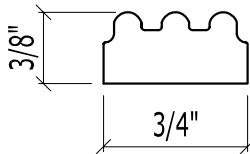

PM 026

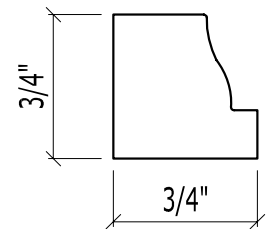

PM 027

PANEL MOULDINGS

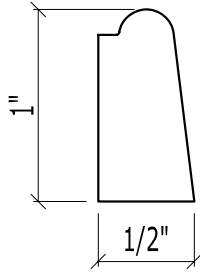

PM 028

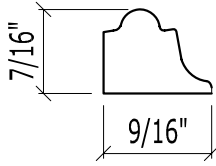

PM 029

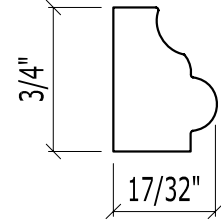

PM 030

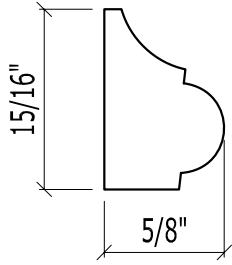

PM 031

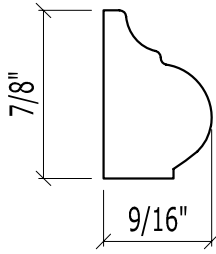

PM 032

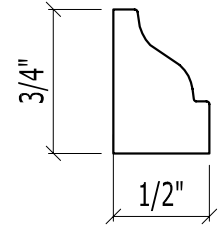

PM 033

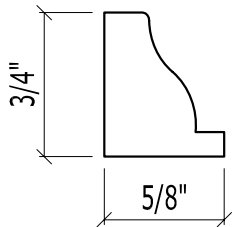

PM 034

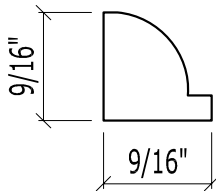

PM 035

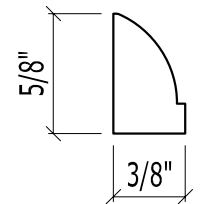

PM 036

PANEL MOULDINGS

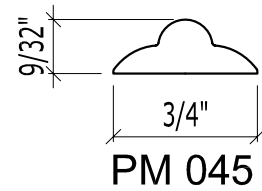
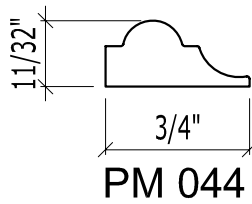
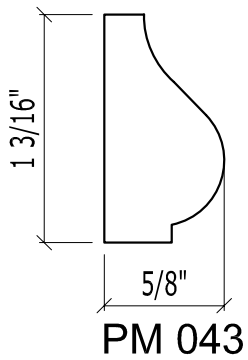
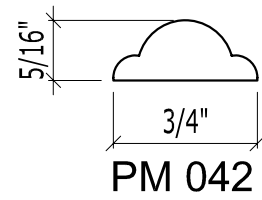
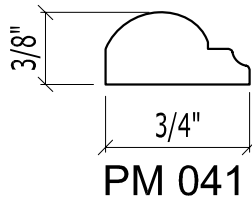
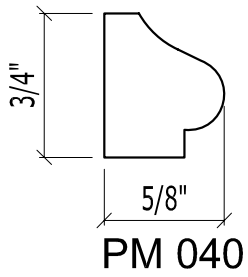
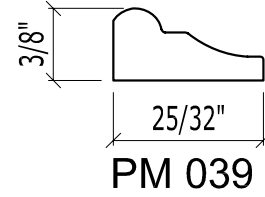
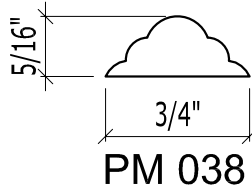
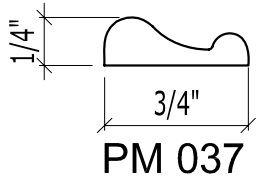

PANEL MOULDINGS

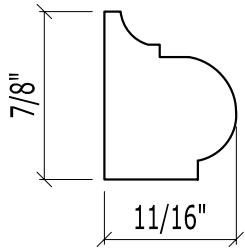

PM 046

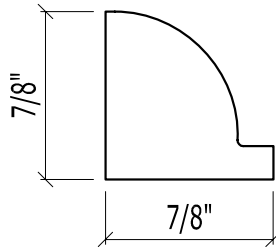

PM 047

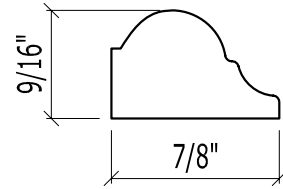

PM 048

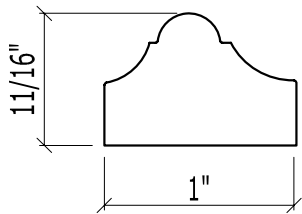

PM 049

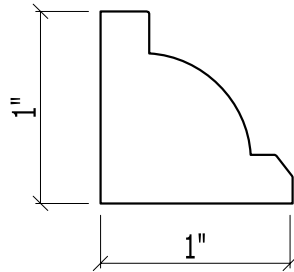

PM 050

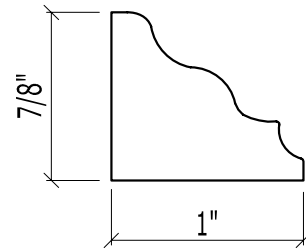

PM 051

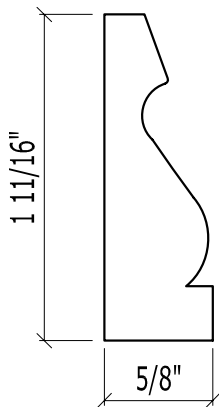

PM 052

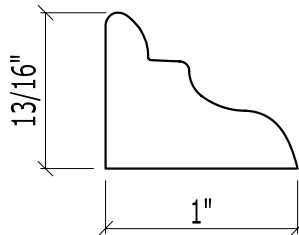

PM 053

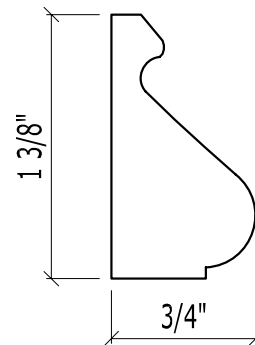

PM 054

PANEL MOULDINGS

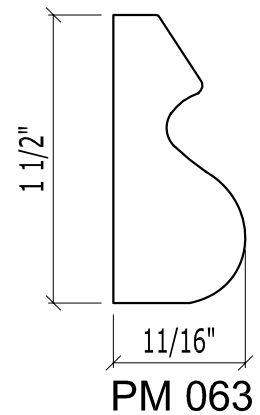
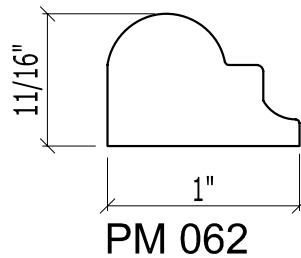
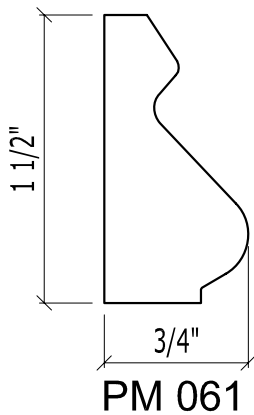
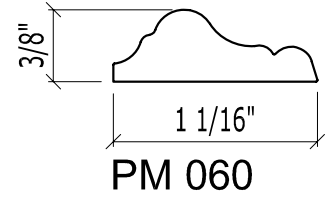
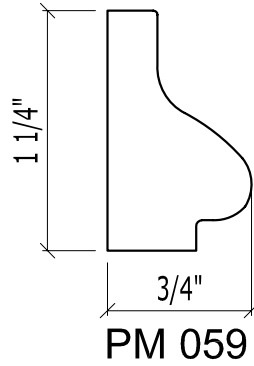
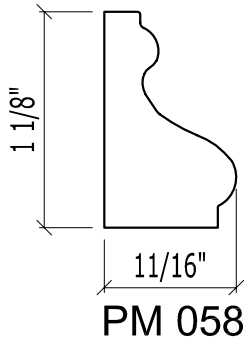
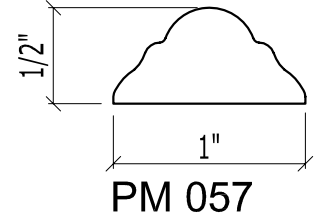
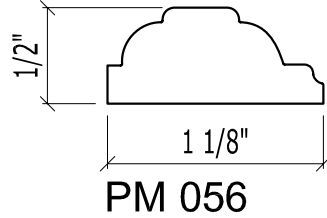
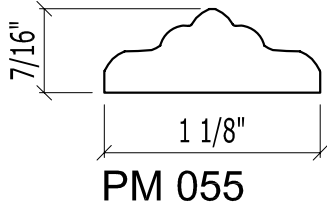

PANEL MOULDINGS

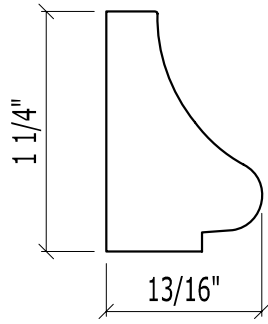

PM 064

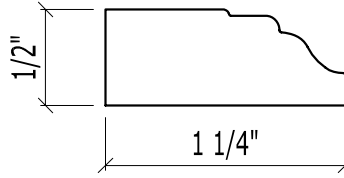

PM 065

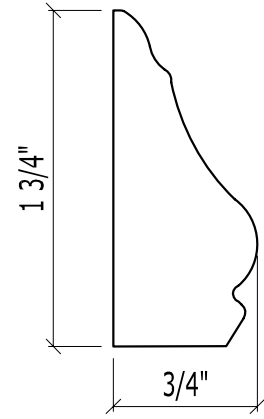

PM 066

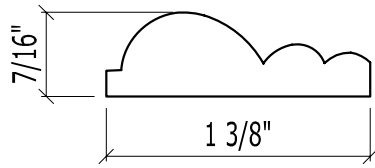

PM 067

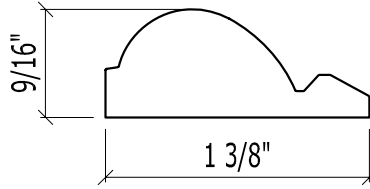

PM 068

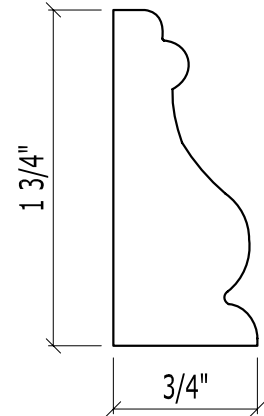

PM 069

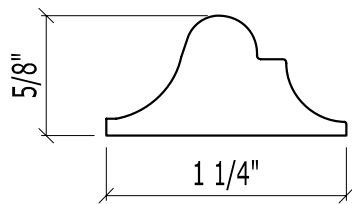

PM 070

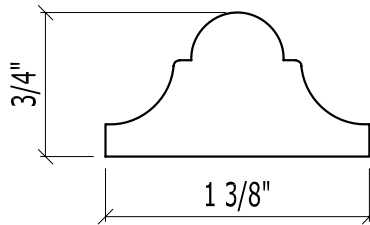

PM 071

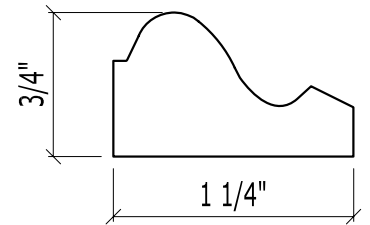

PM 072

PANEL MOULDINGS

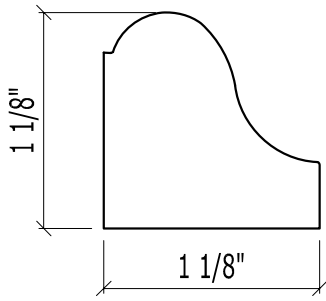

PM 073

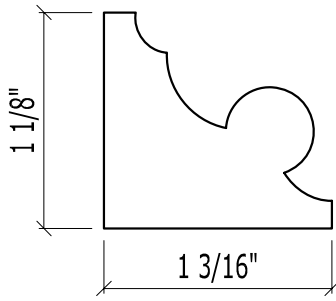

PM 074

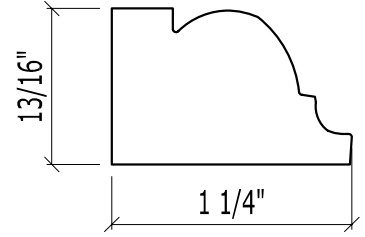

PM 075

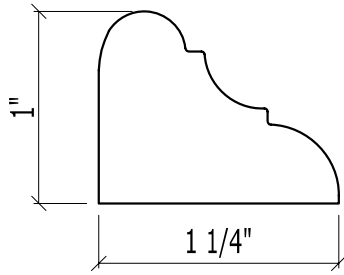

PM 076

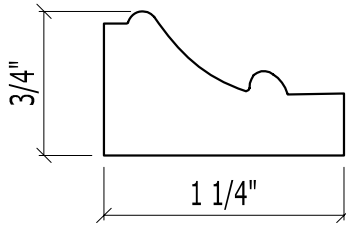

PM 077

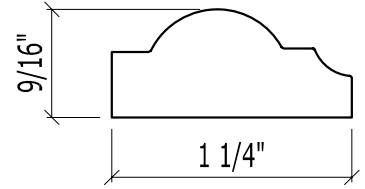

PM 078

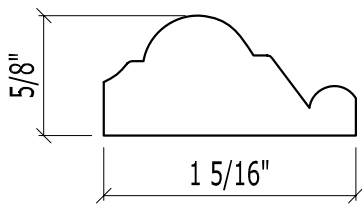

PM 079

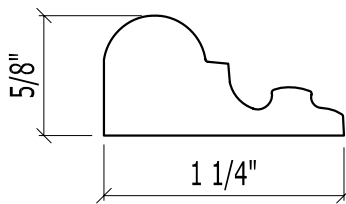

PM 080

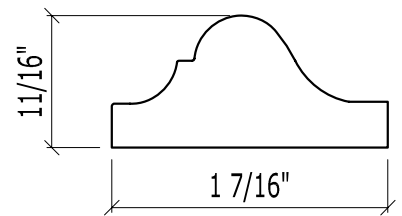

PM 081

PANEL MOULDINGS

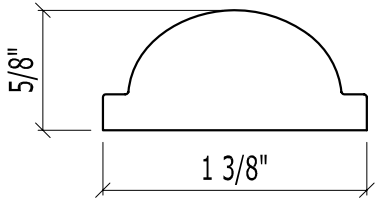

PM 082

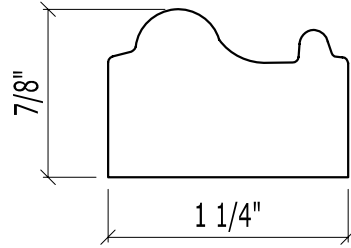

PM 083

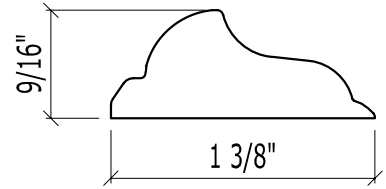

PM 084

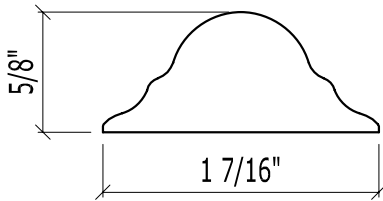

PM 085

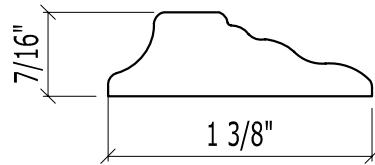

PM 086

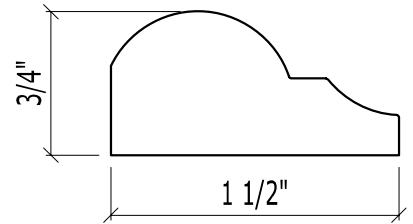

PM 087

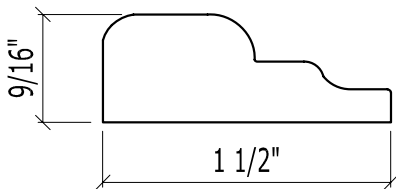

PM 088

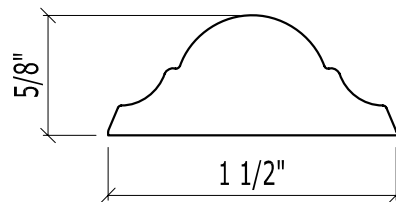

PM 089

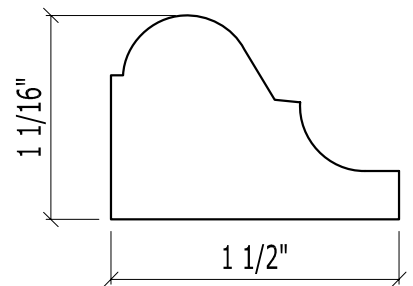

PM 090

PANEL MOULDINGS

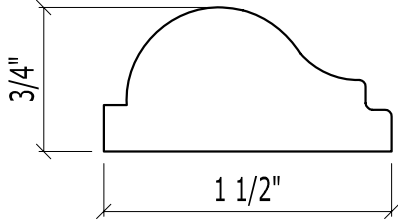

PM 091

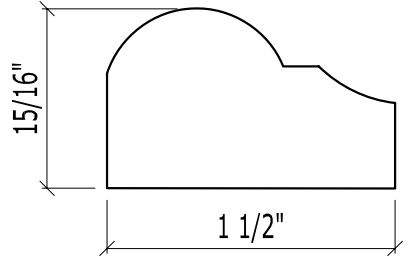

PM 092

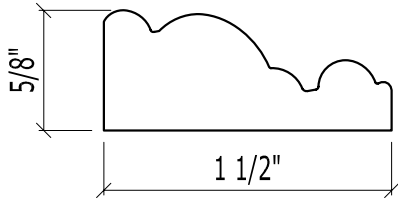

PM 093

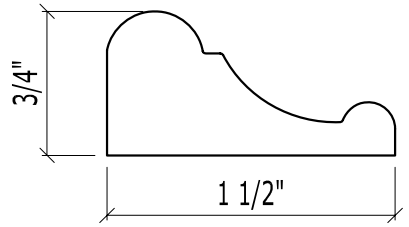

PM 094

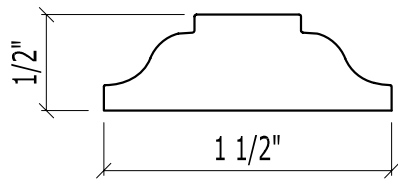

PM 095

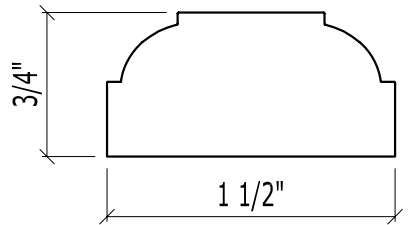

PM 096

PANEL MOULDINGS

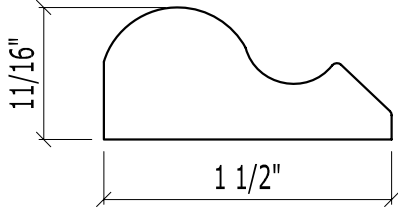

PM 097

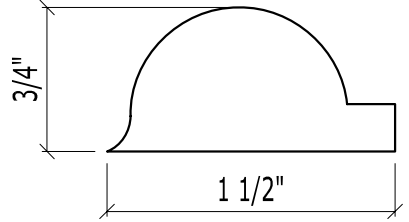

PM 098

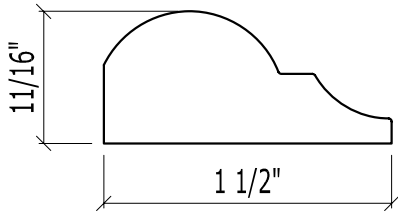

PM 099

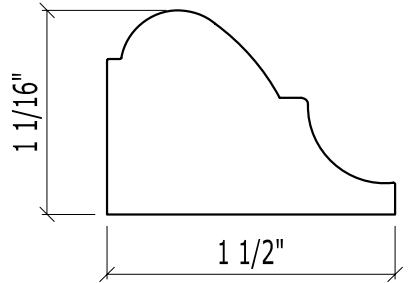

PM 100

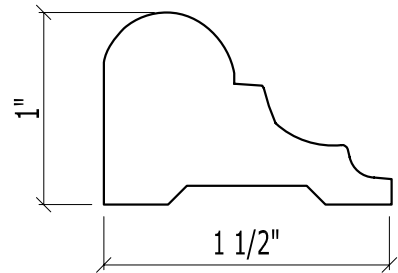

PM 101

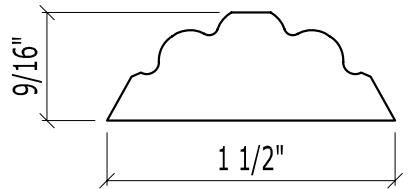

PM 102

PANEL MOULDINGS

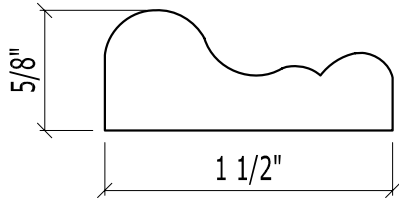

PM 103

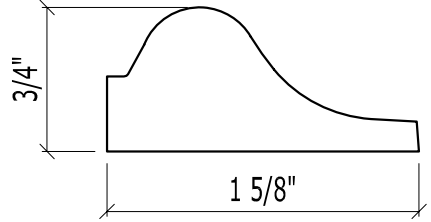

PM 104

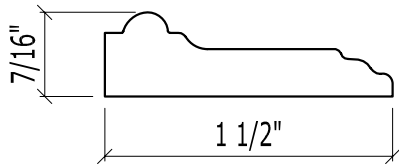

PM 105

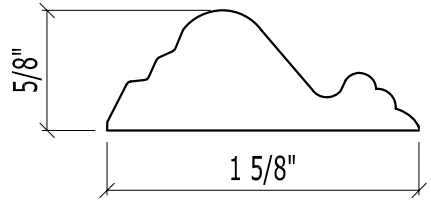

PM 106

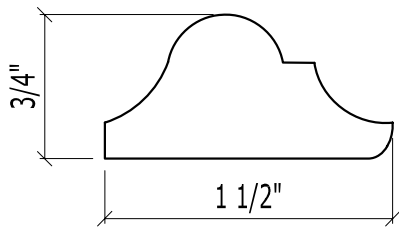

PM 107

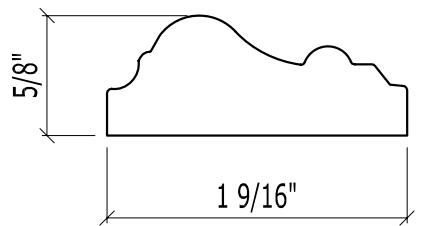

PM 108

PANEL MOULDINGS

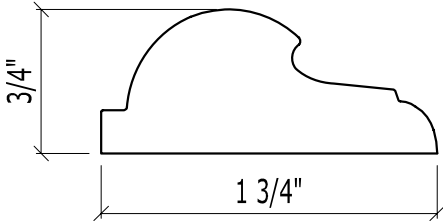

PM 109

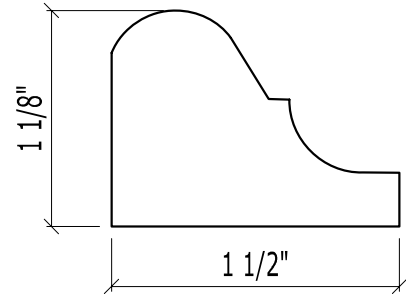

PM 110

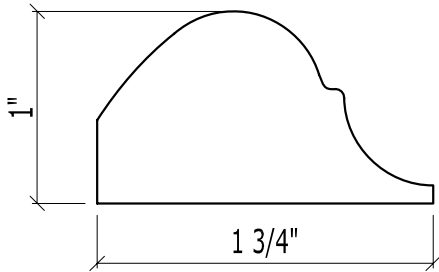

PM 111

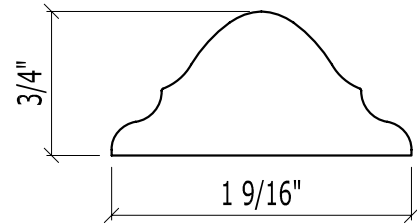

PM 112

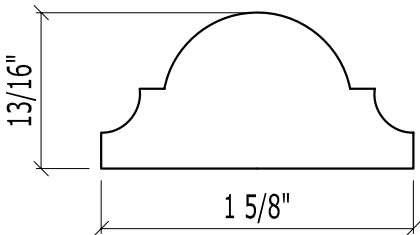

PM 113

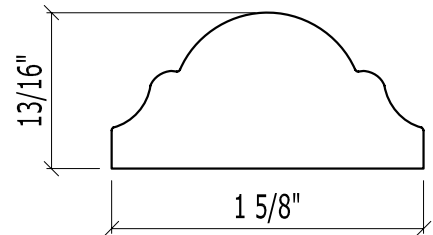

PM 114

PANEL MOULDINGS

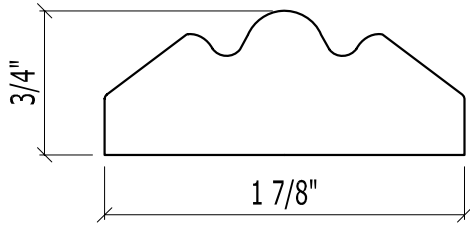

PM 115

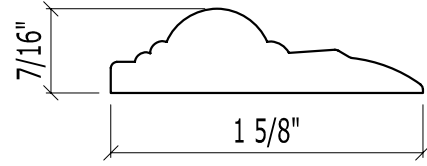

PM 116

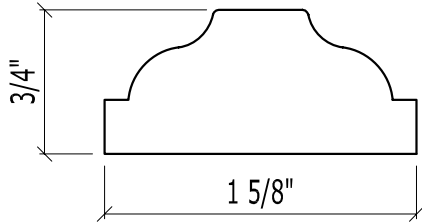

PM 117

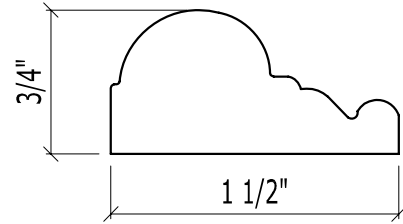

PM 118

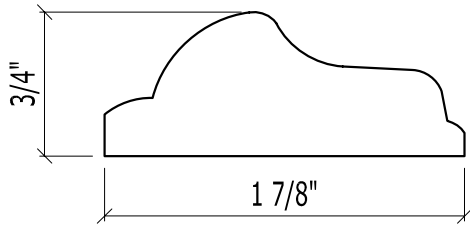

PM 119

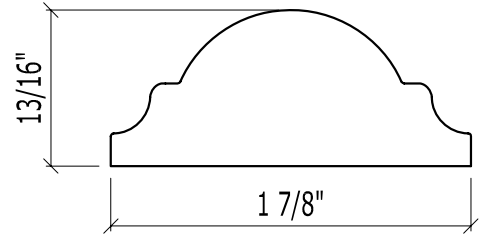

PM 120

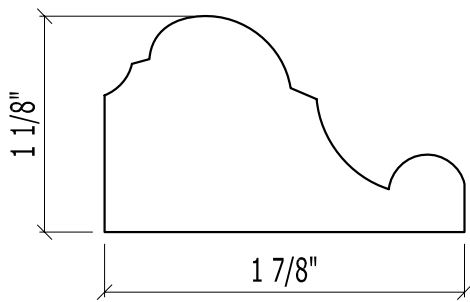

PM 121

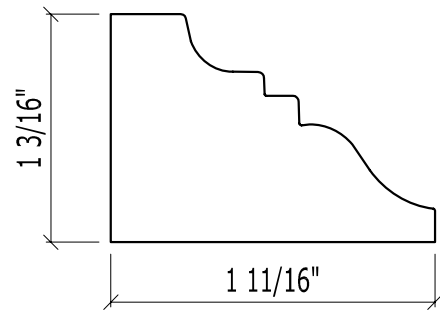

PM 122

PANEL MOULDINGS

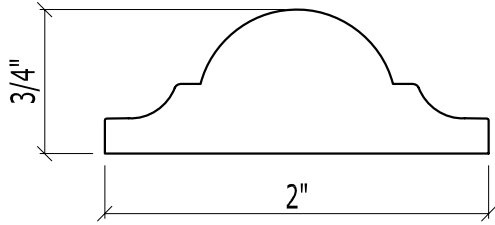

PM 123

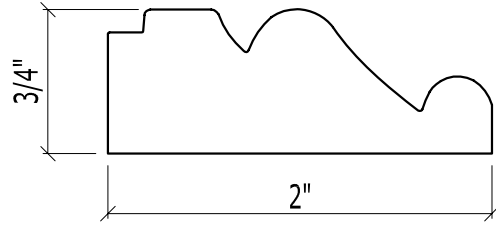

PM 124

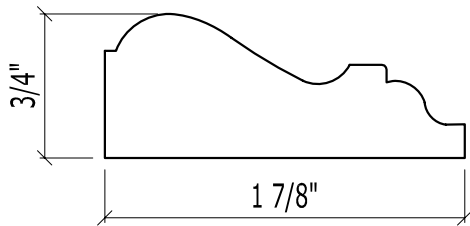

PM 125

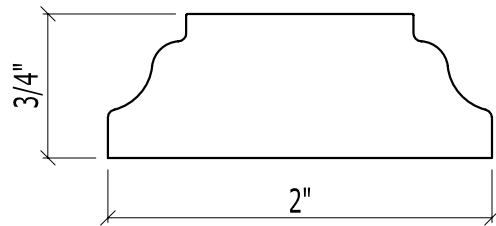

PM 126

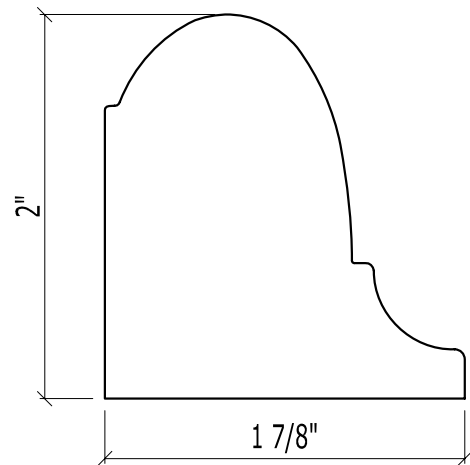

PM 127

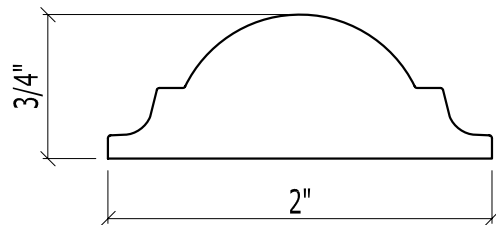

PM 128

PANEL MOULDINGS

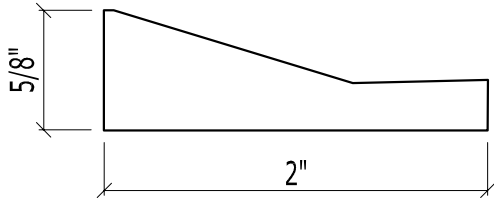

PM 129

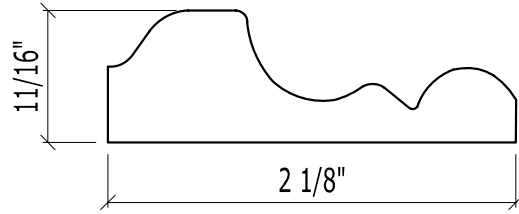

PM 130

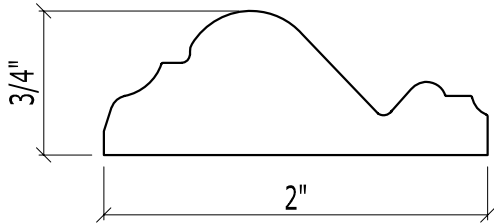

PM 131

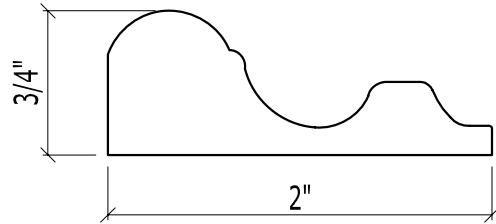

PM 132

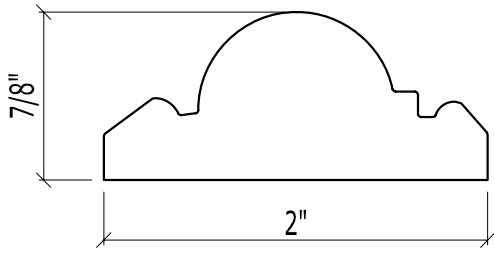

PM 133

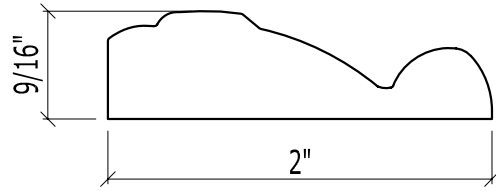

PM 134

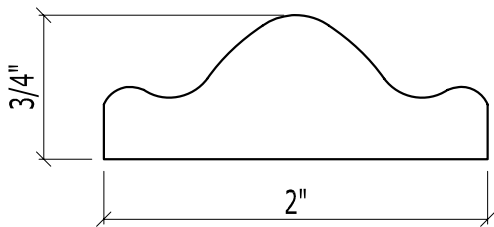

PM 135

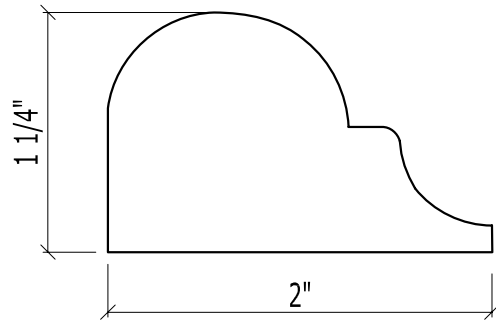

PM 136

PANEL MOULDINGS

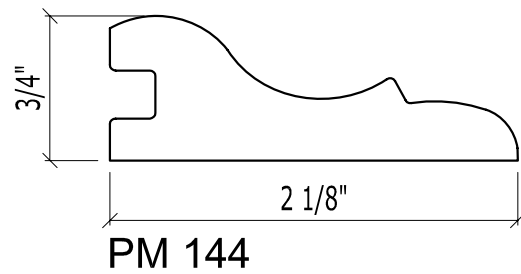
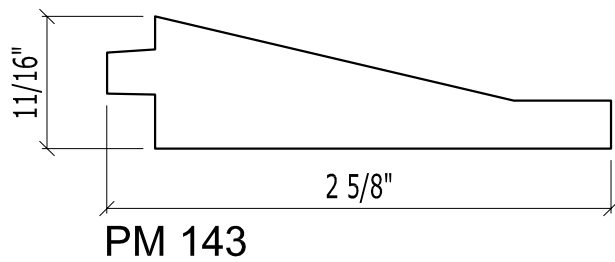
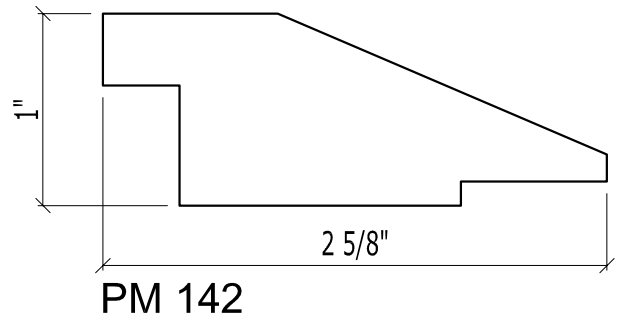
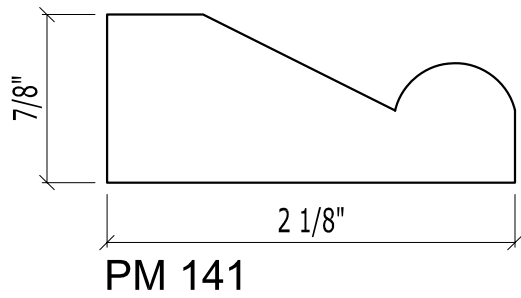
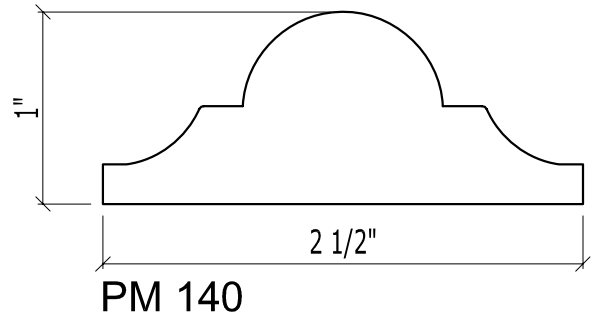
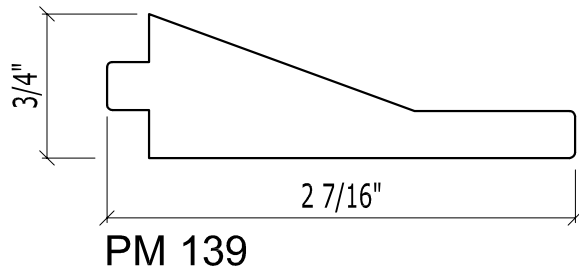
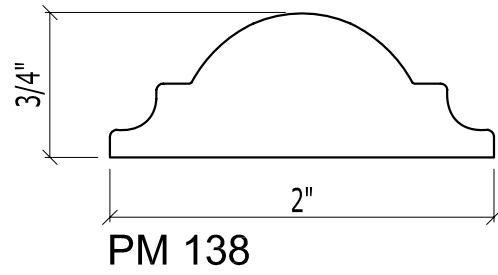
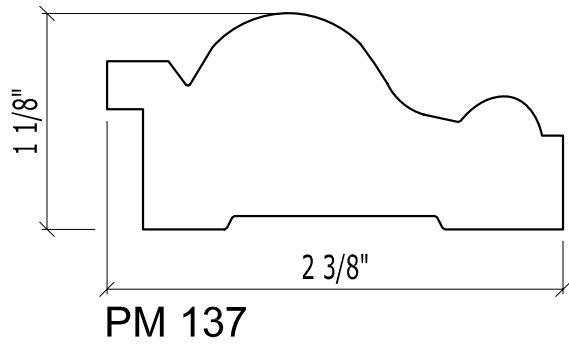

PANEL MOULDINGS

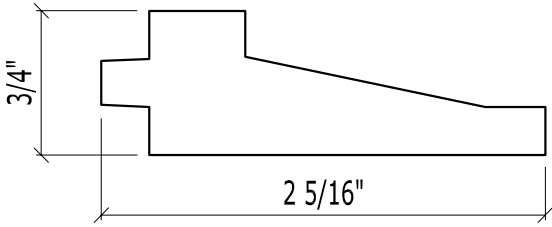

PM 145

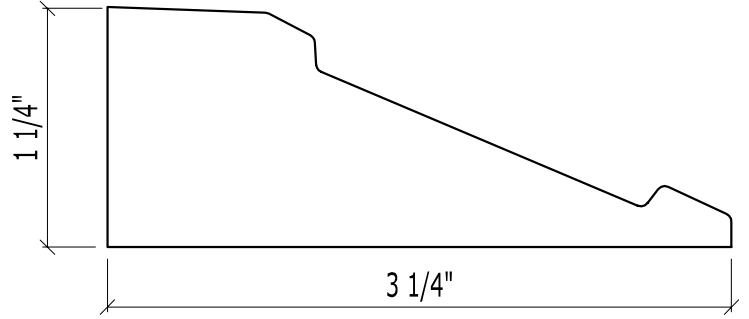

PM 146

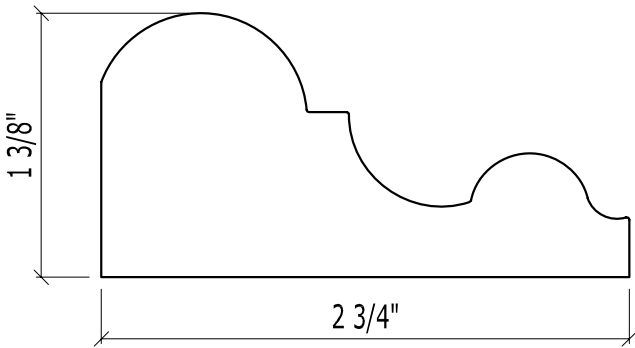

PM 147

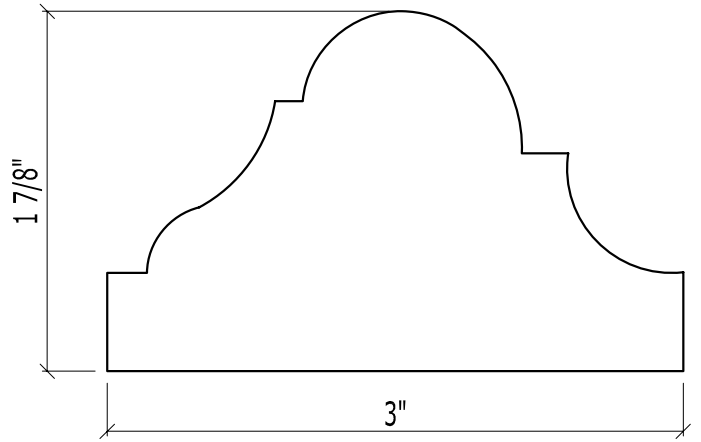

PM 148

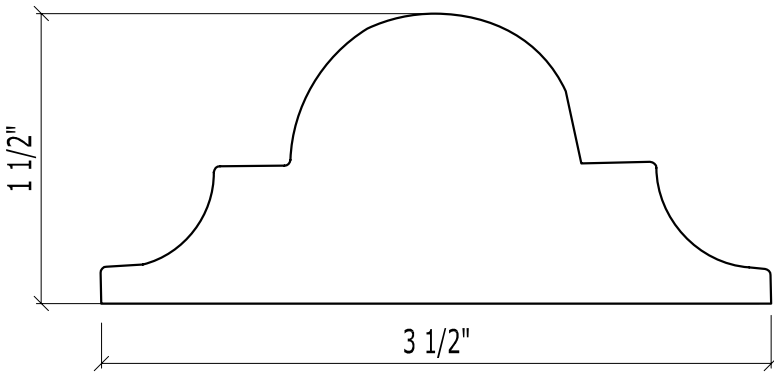

PM 149

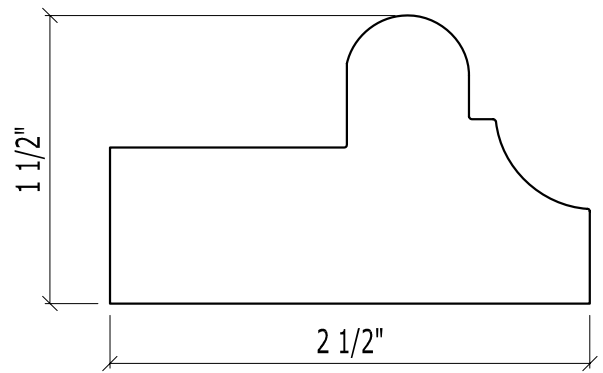

PM 150

PANEL MOULDINGS

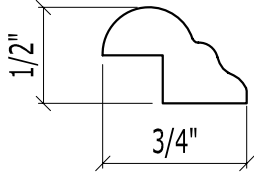

PM 151

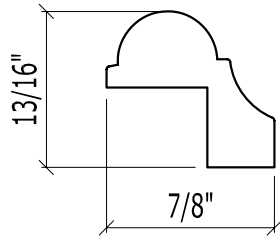

PM 152

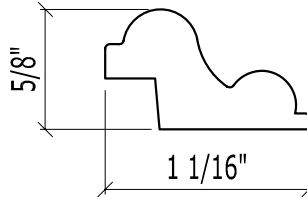

PM 153

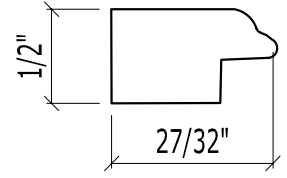

PM 154

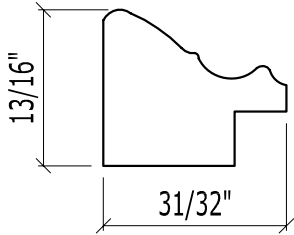

PM 155

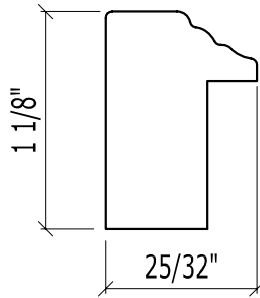

PM 156

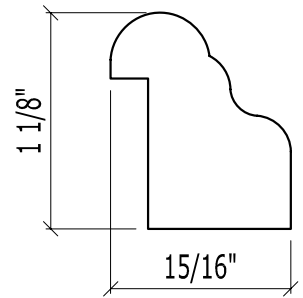

PM 157

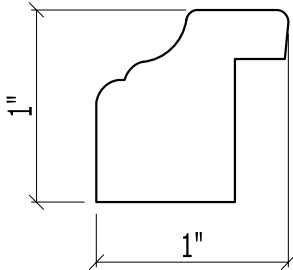

PM 158

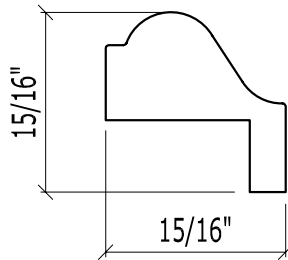

PM 159

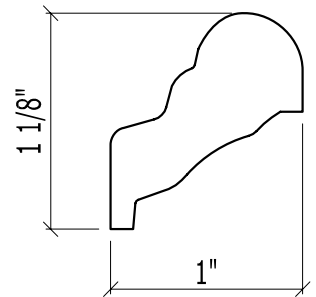

PM 160

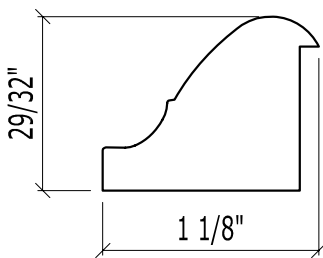

PM 161

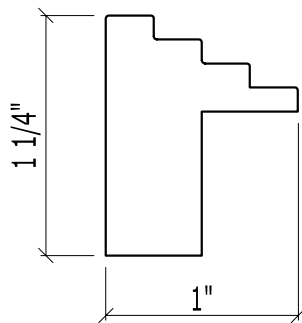

PM 162

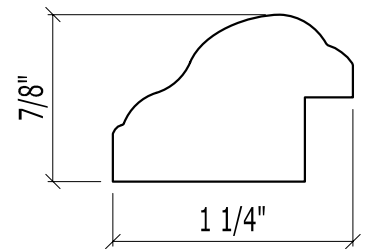

PM 163

PANEL MOULDINGS

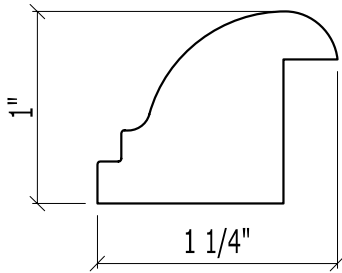

PM 164

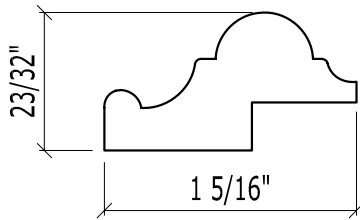

PM 165

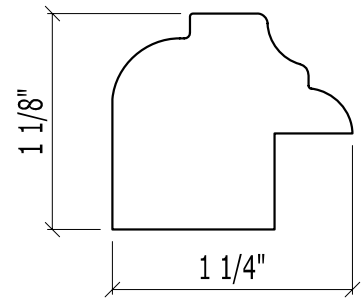

PM 166

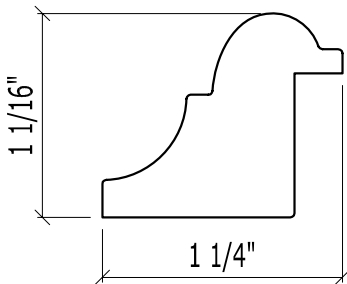

PM 167

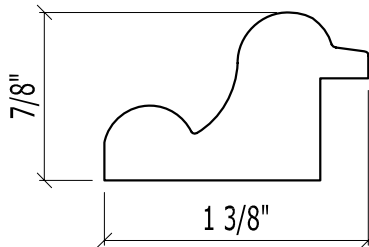

PM 168

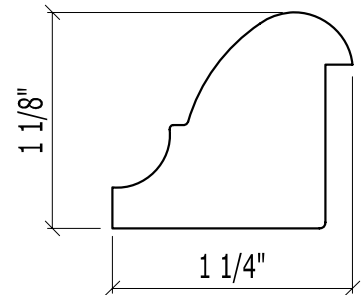

PM 169

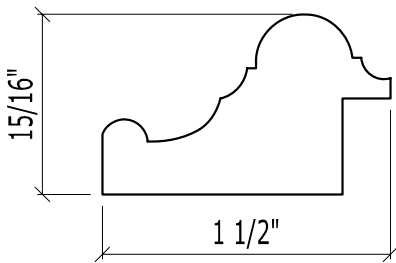

PM 170

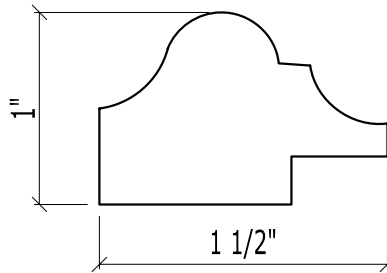

PM 171

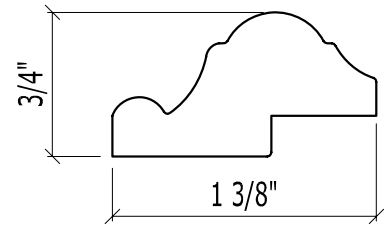

PM 172

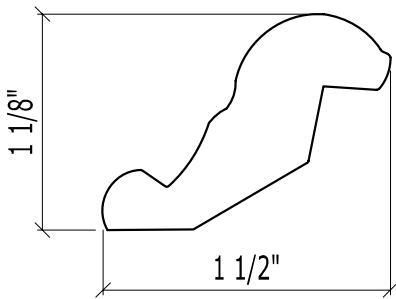

PM 173

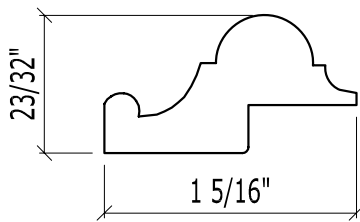

PM 174

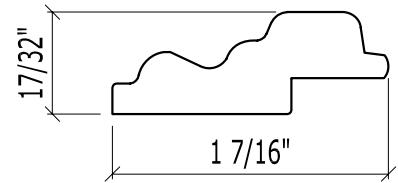

PM 175

PANEL MOULDINGS

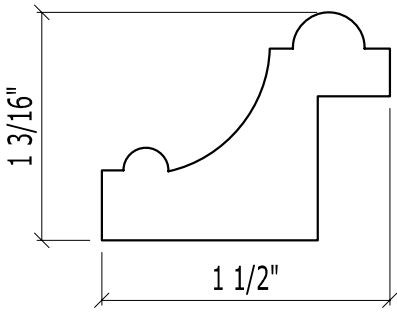

PM 176

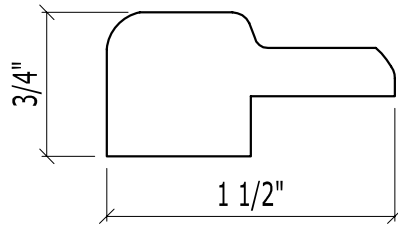

PM 177

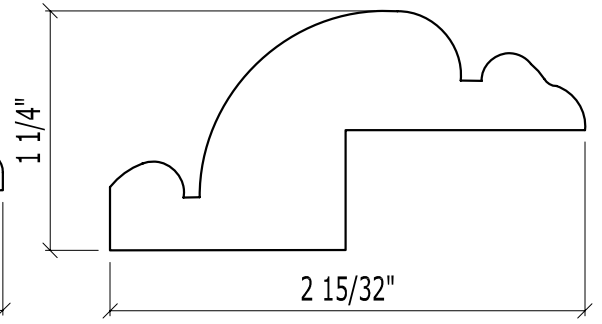

PM 178

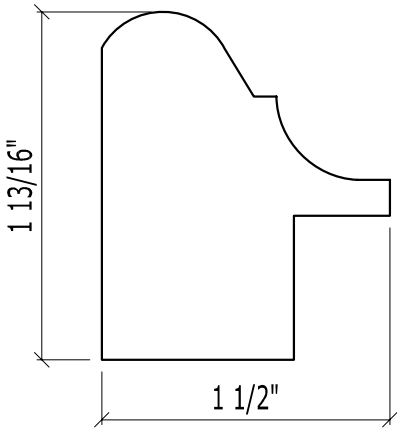

PM 179

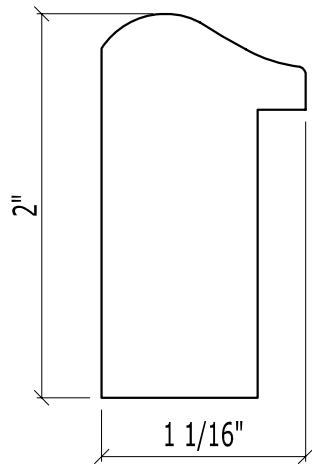

PM 180

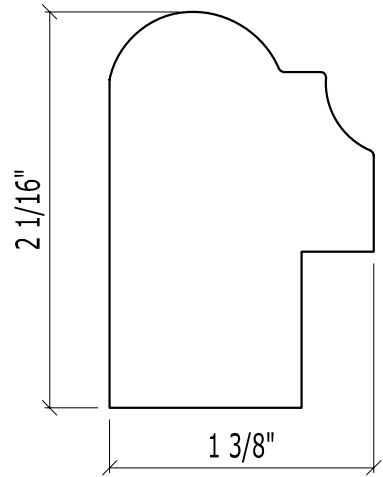

PM 181

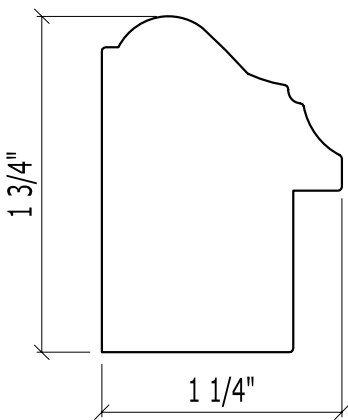

PM 182

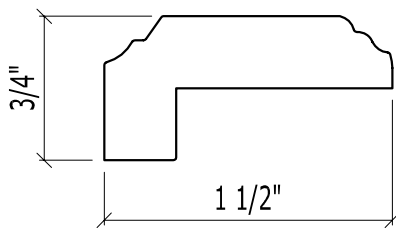

PM 183

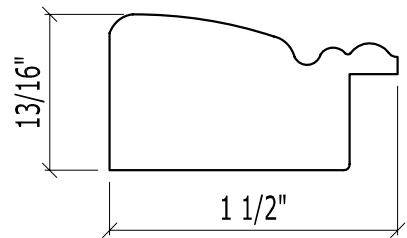

PM 184

PANEL MOULDINGS

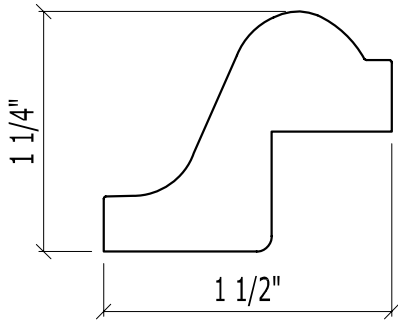

PM 185

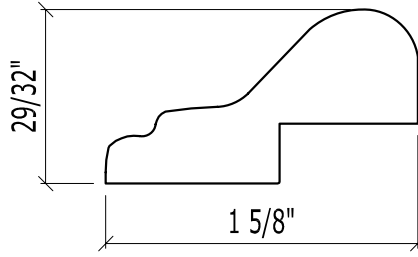

PM 186

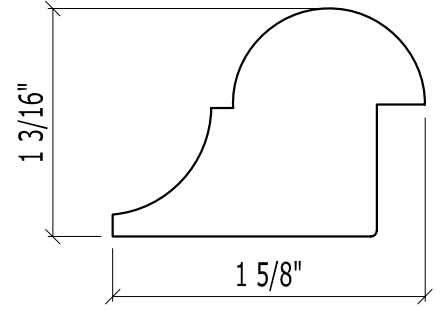

PM 187

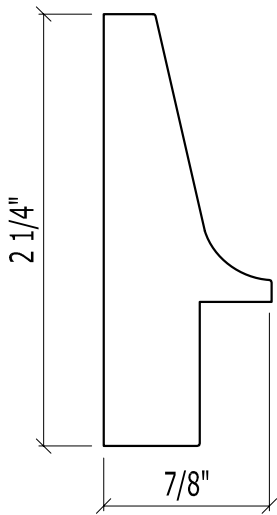

PM 188

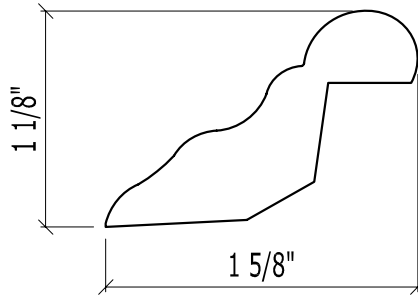

PM 189

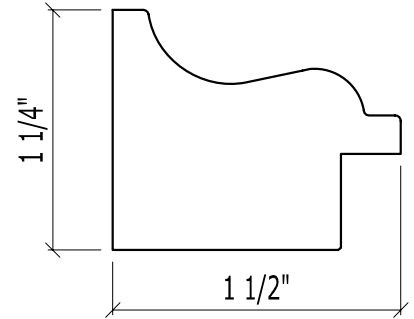

PM 190

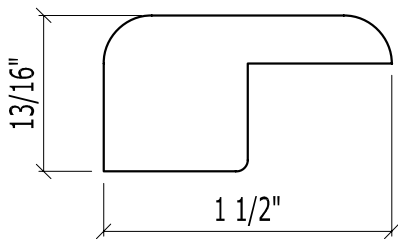

PM 191

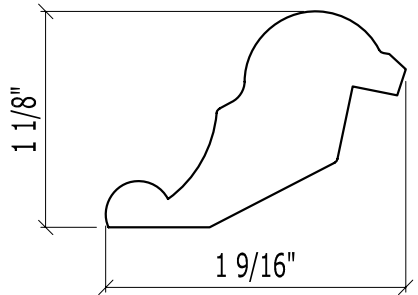

PM 192

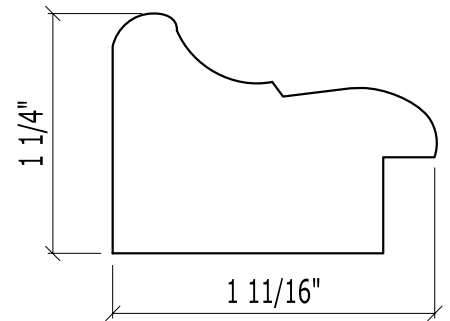

PM 193

PANEL MOULDINGS

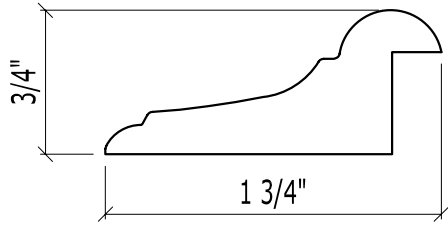

PM 194

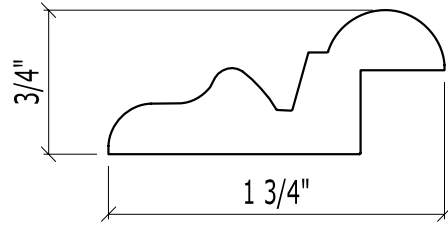

PM 195

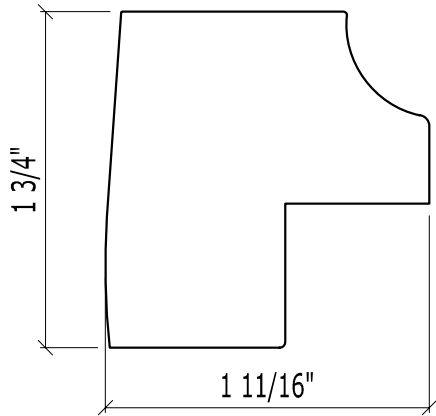

PM 196

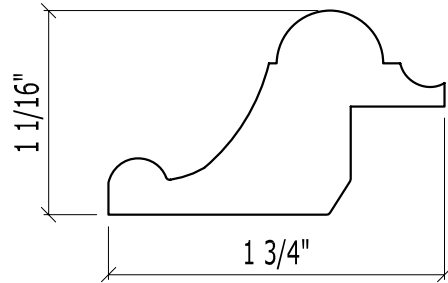

PM 197

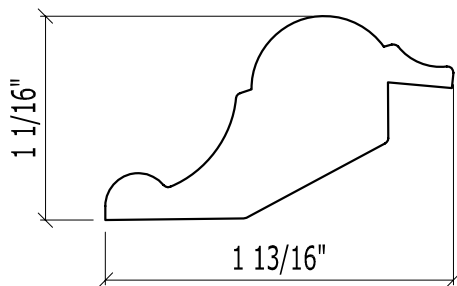

PM 198

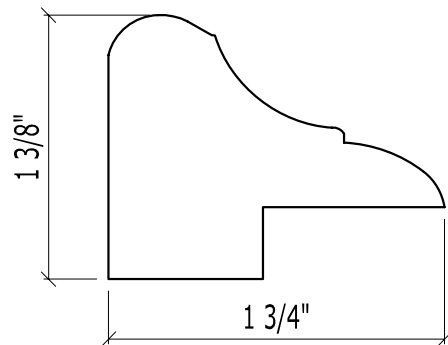

PM 199

PANEL MOULDINGS

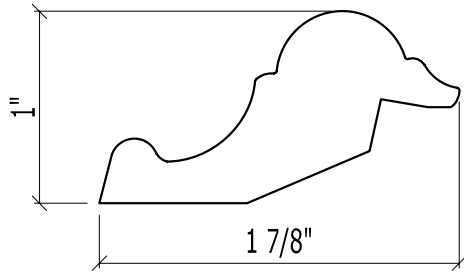

PM 200

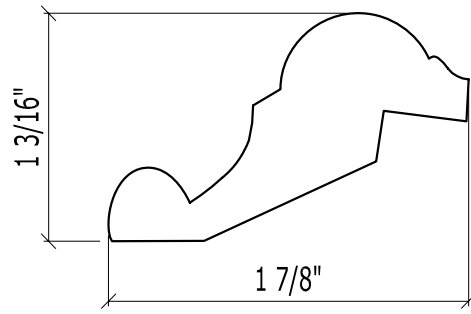

PM 201

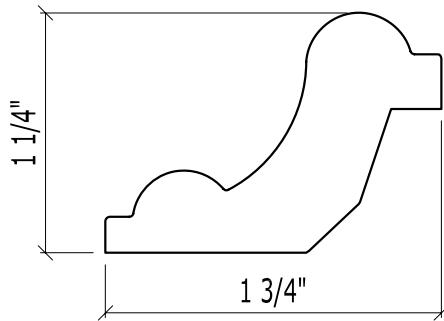

PM 202

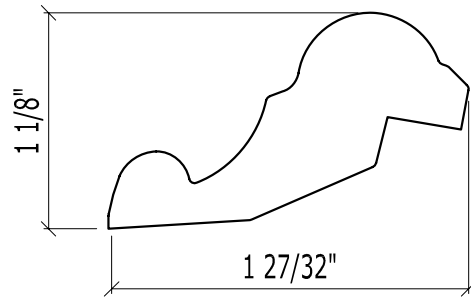

PM 203

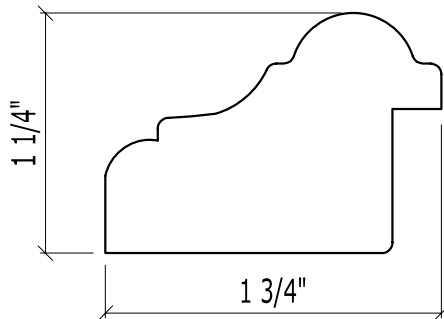

PM 204

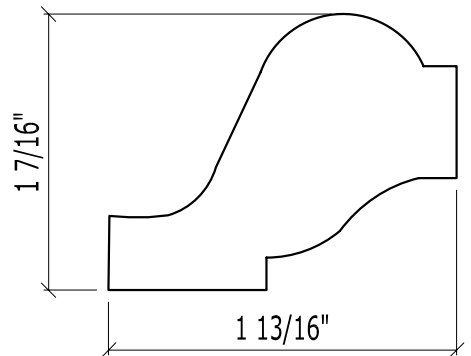

PM 205

PANEL MOULDINGS

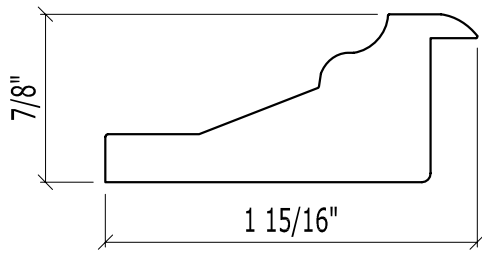

PM 206

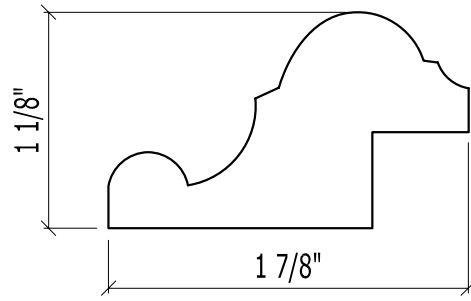

PM 207

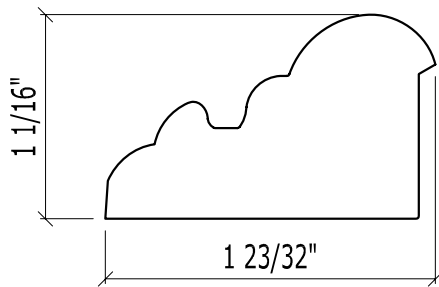

PM 208

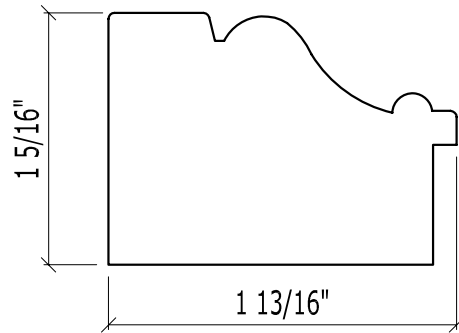

PM 209

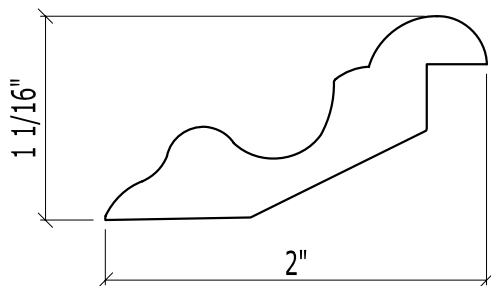

PM 210

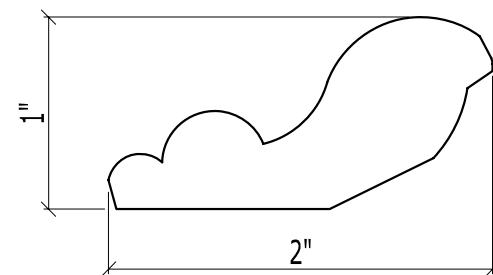

PM 211

PANEL MOULDINGS

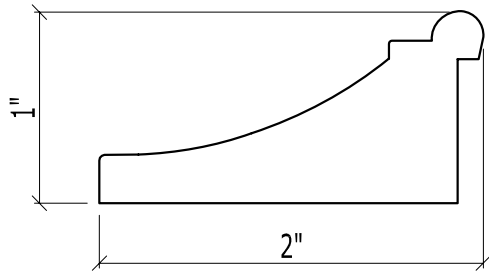

PM 212

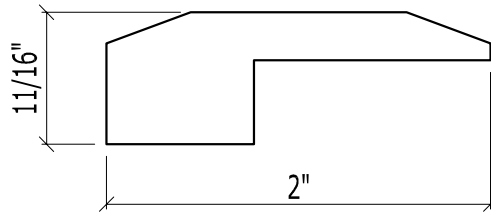

PM 213

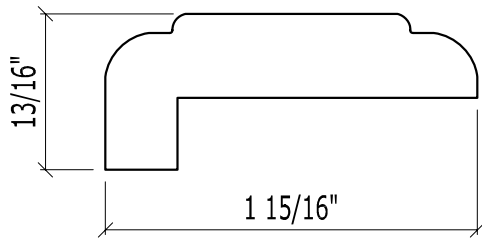

PM 214

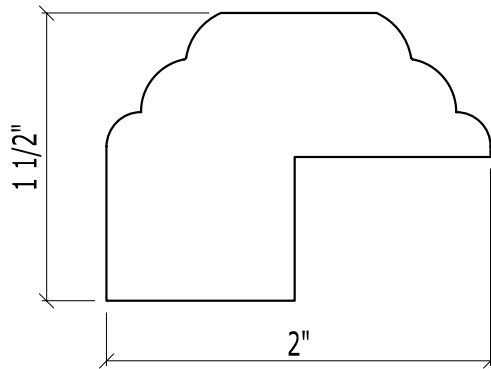

PM 215



PM 216

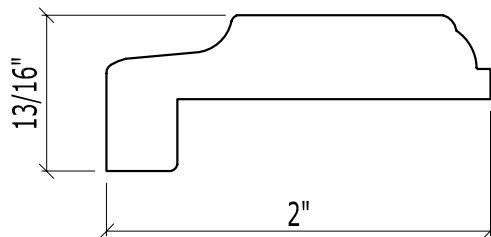

PM 217

PANEL MOULDINGS

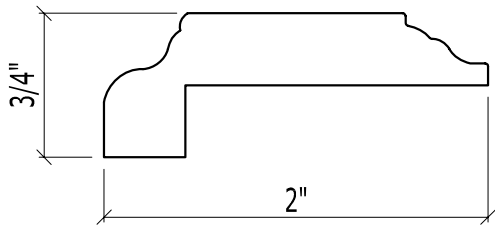

PM 218

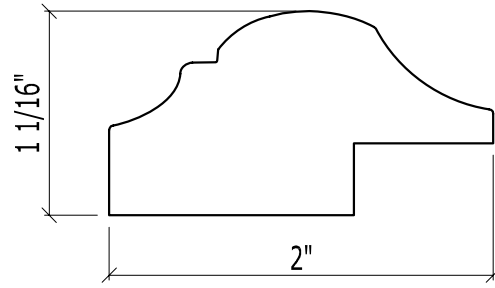

PM 219

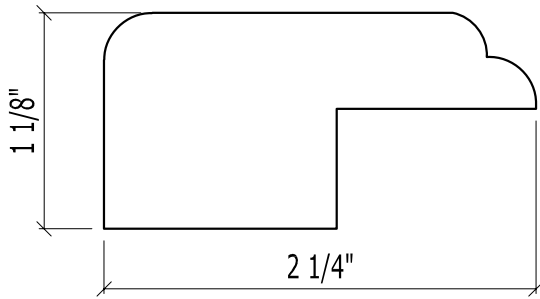

PM 220

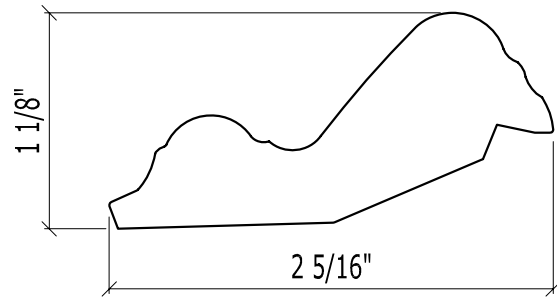

PM 221

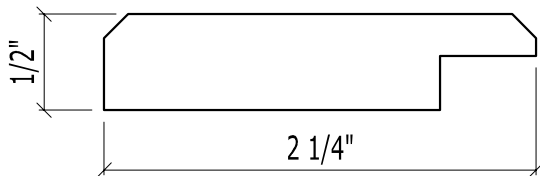

PM 222

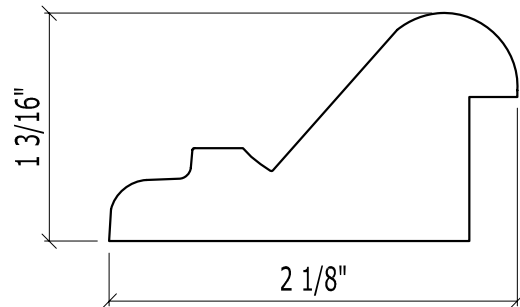

PM 223

PANEL MOULDINGS

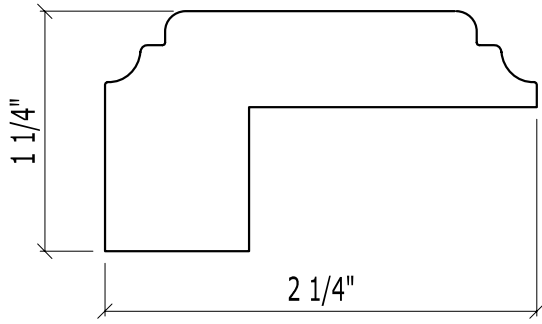

PM 224

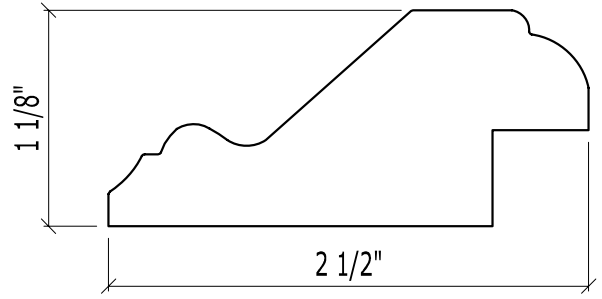

PM 225

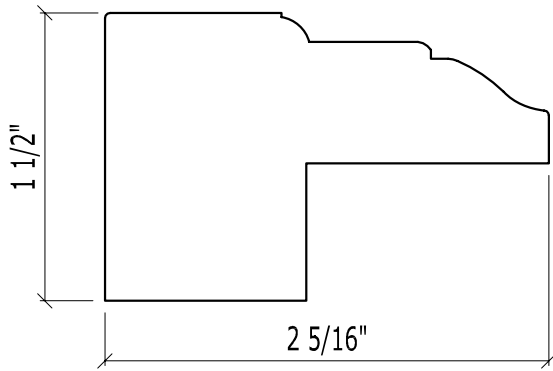

PM 226

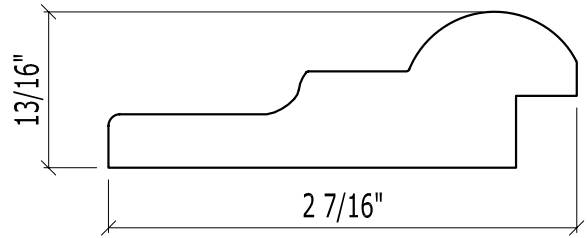

PM 227

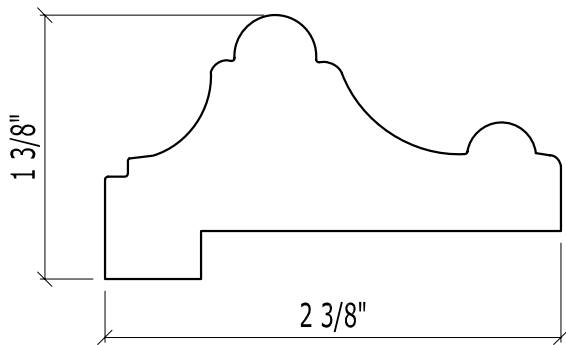

PM 228

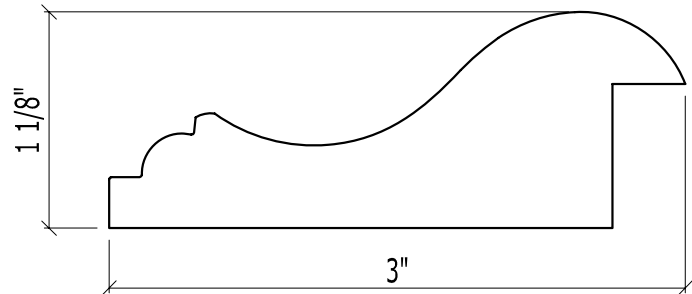

PM 229

PANEL MOULDINGS

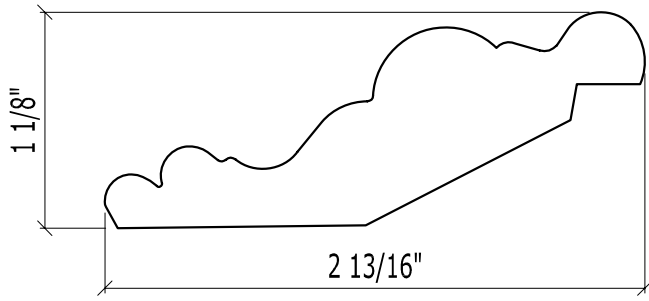

PM 230

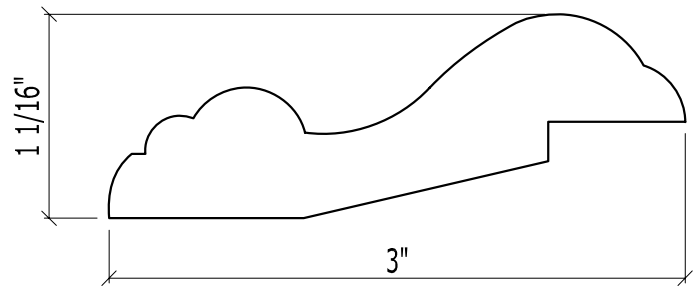

PM 231

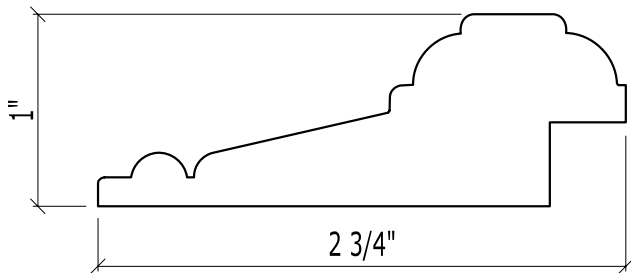

PM 232

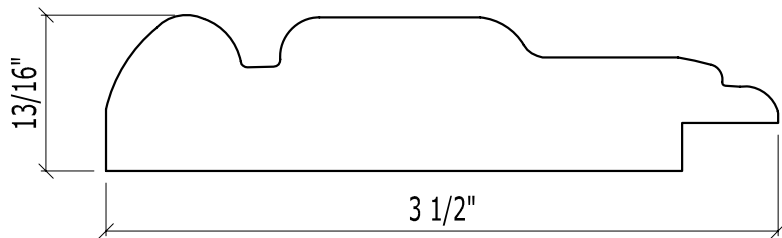

PM 233

PANEL MOULDINGS

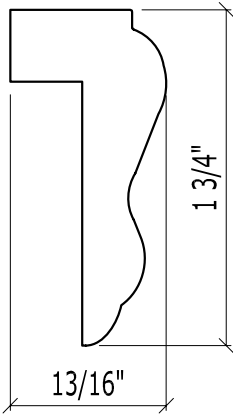

PM 234

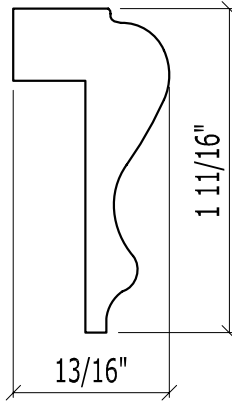

PM 235

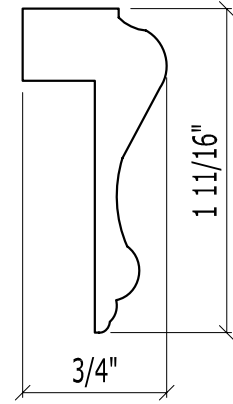

PM 236

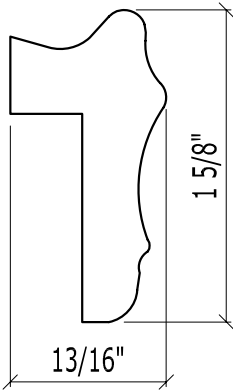

PM 237

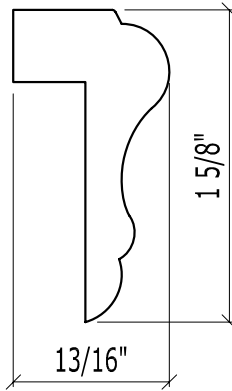

PM 238

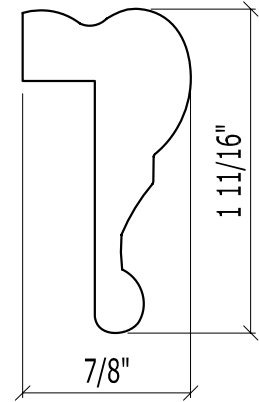

PM 239

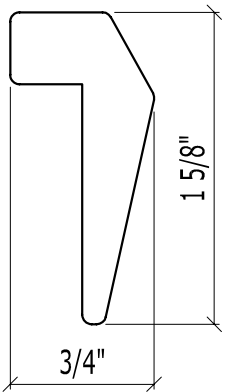

PM 240

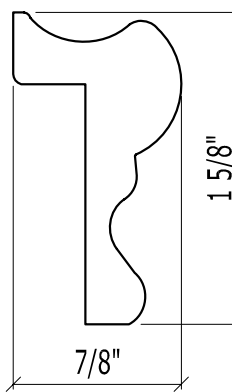

PM 241

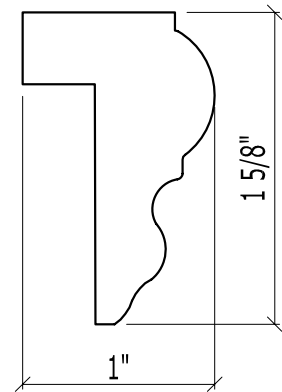

PM 242

PANEL MOULDINGS

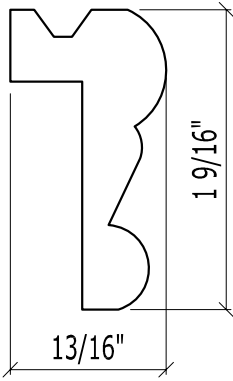

PM 243

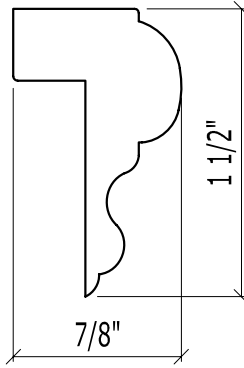

PM 244

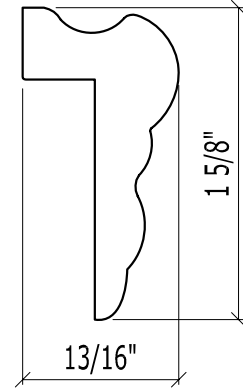

PM 245

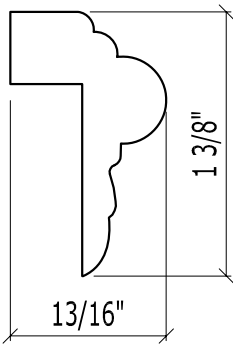

PM 246

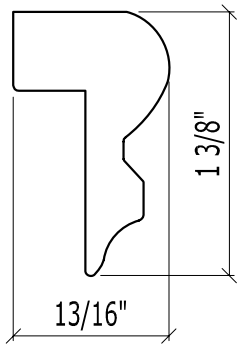

PM 247

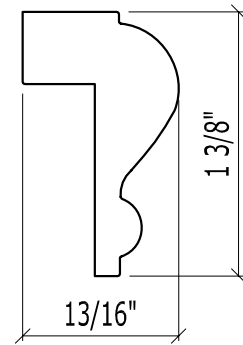

PM 248

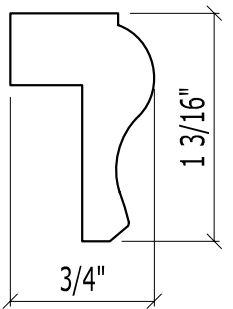

PM 249

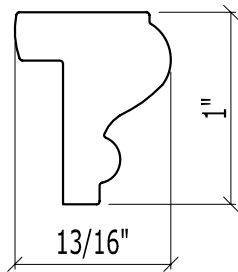

PM 250

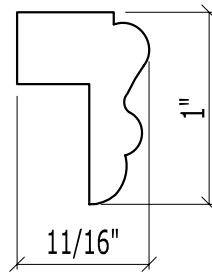

PM 251

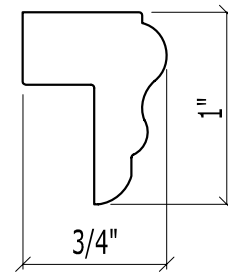

PM 252